

PVT422P

Microelectronic Power IC
HEXFET® Power MOSFET Photovoltaic Relay
Dual Pole, Normally Open
0-400V, 120mA AC/DC

General Description

The PVT422P Series Photovoltaic Relay is a dual-pole, normally open solid-state relay that can replace electromechanical relays in many applications. It utilizes International Rectifier's HEXFET power MOSFET as the output switch, driven by an integrated circuit photovoltaic generator of novel construction. The output switch is controlled by radiation from a GaAlAs light emitting diode (LED) which is optically isolated from the photovoltaic generator.

PVT422P is ideally suited for PCMCIA card applications. Its extremely low profile allows it to be used in Type II cards whose outer shells are only 5mm thick.

Series PVT422P Relays are packaged in an 8-pin, molded 'Thin-Pak' DIP package with 'gull-wing' surface mount terminals. It is available in plastic shipping tubes or on tape-and-reel. Please refer to Part Identification (opposite) for details.

Features

- HEXFET Power MOSFET output
- Bounce-free operation
- 3,750 V_{RMS} I/O isolation
- Load current limiting
- Linear AC/DC operation
- Solid-State Reliability
- BAPT certified

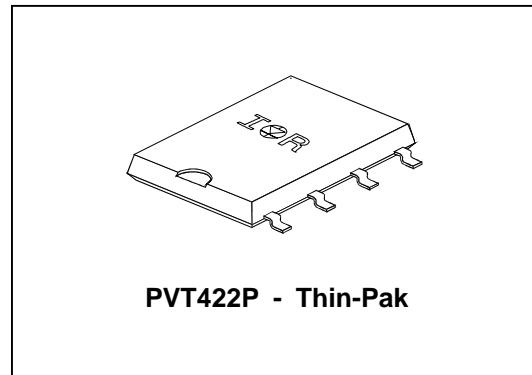

Applications

- On/Off Hook switch
- Dial-Out relay
- Ring injection relay
- General switching

Part Identification

PVT422P surface-mount, plastic shipping tube

PVT422P-T surface-mount, tape-and-reel

Electrical Specifications (-40°C T_A+85°C unless otherwise specified)

INPUT CHARACTERISTICS	Limits	Units
Minimum Control Current (See figure1)	2.0	mA
Maximum Control Current for Off-State Resistance @T _A =+25°C	0.4	mA
Control Current Range (Caution: current limit input LED, see figure 5)	2.0 to 25	mA
Maximum Reverse Voltage	7.0	V

OUTPUT CHARACTERISTICS	Limits	Units
Operating Voltage Range	0 to ±400	V _(DC or AC peak)
Maximum Load Current @ T _A =+40°C 5mA Control (See figure 1) (single and dual channel operation)	120	mA
Maximum Peak Load Current (10ms maximum duration) (single and dual channel operation)	350	mA
Maximum On-State Resistance @T _A =+25°C For 50mA Pulsed load, 5mA Control (see figure3)	35	Ω
Maximum Off-State Leakage @T _A =+25°C, ±320V (see figure 4)	1.0	μA
Maximum Turn-On Time @T _A =+25°C (see figure 6) For 50mA, 100 V _{DC} load, 5mA Control	2.0	ms
Maximum Turn-Off Time @T _A =+25°C (see figure 6) For 50mA, 100 V _{DC} load, 5mA Control	2.0	ms
Maximum Output Capacitance @ 50V _{DC}	12	pF

GENERAL CHARACTERISTICS	Limits	Units
Minimum Dielectric Strength, Input-Output	3750	V _{RMS}
Minimum Dielectric Strength, Pole-to-Pole	1000	V _{DC}
Minimum Insulation Resistance, Input-Output, @T _A =+25°C, 50%RH, 100V _{DC}	10 ¹²	
Maximum Capacitance, Input-Output	1.0	pF
Maximum Pin Soldering Temperature (10 seconds maximum)	+260	
Ambient Temperature Range:	Operating	-40 to +85
	Storage	-40 to +100

Connection Diagram

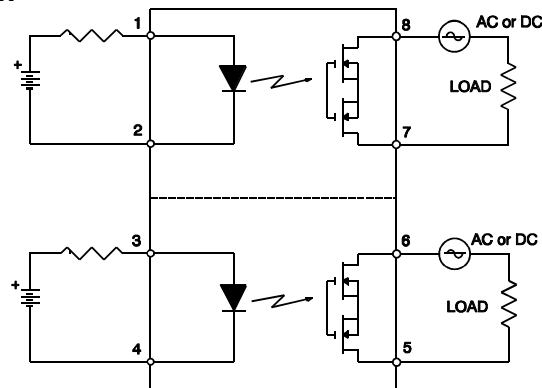

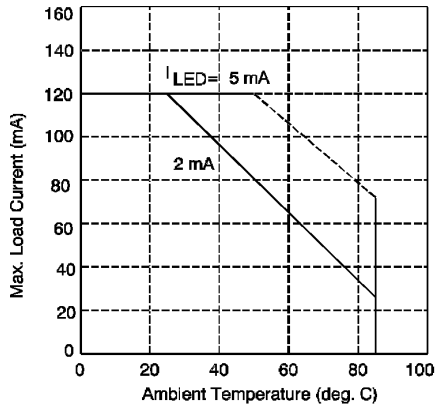

Figure 1. Typical Current Derating Curve

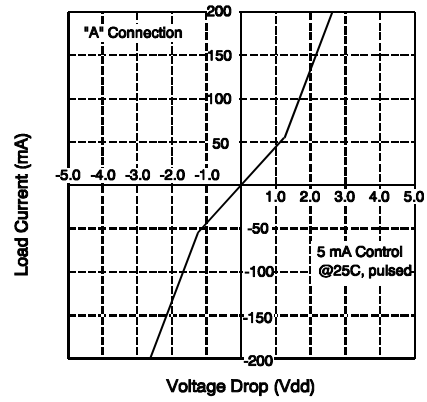

Figure 2. Linearity Characteristics

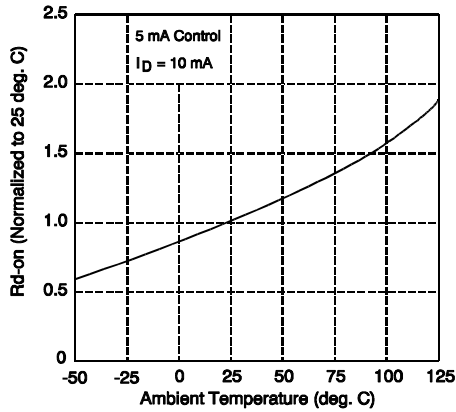

Figure 3. Typical Normalized On-Resistance

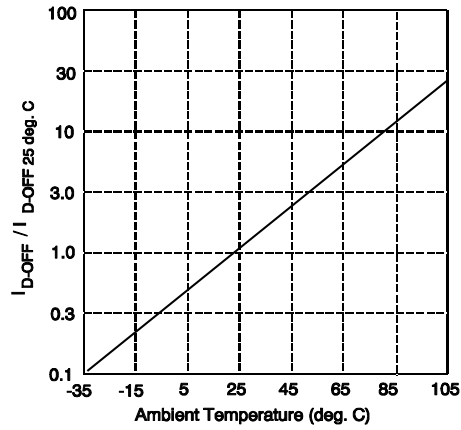

Figure 4. Typical Normalized Off-State Leakage

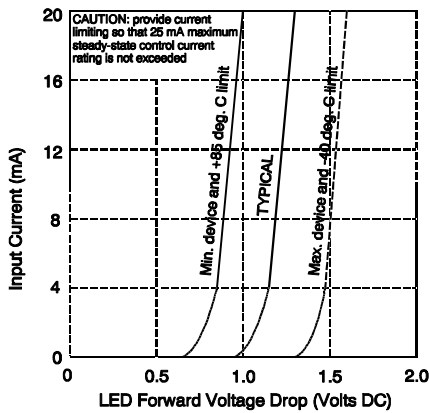

Figure 5. Input Characteristics (Current Controlled)

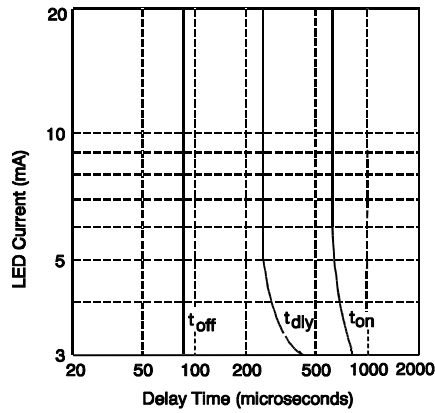

Figure 6. Typical Delay Times

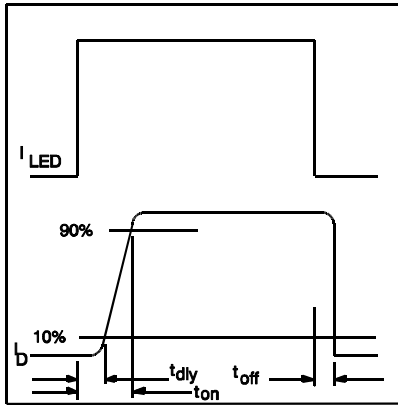

Figure 7. Delay Time Definitions

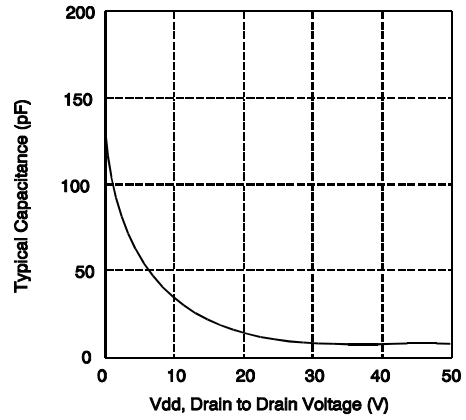

Figure 8. Typical Output Capacitance

Case Outline

